













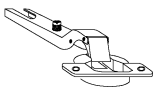
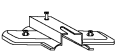

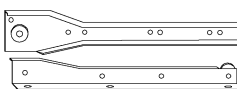
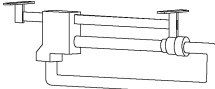
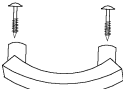
x 12 		x 6 		x 24 		x 24 			
x 8 		x 8 		x 6 		x 3 (400 mm - kpl.) 			
x 2 		x 6 		x 6 		x 12 			
x 36 (3,5x30) 		x 68 (3,5x16) 		x 150 		x 1 		x 1 	



1 - FAZY MONTAŻU

A - OZNACZENIE ELEMENTÓW

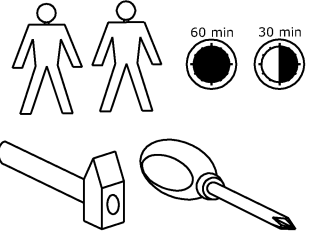
a - OZNACZENIE AKCESORIÓW

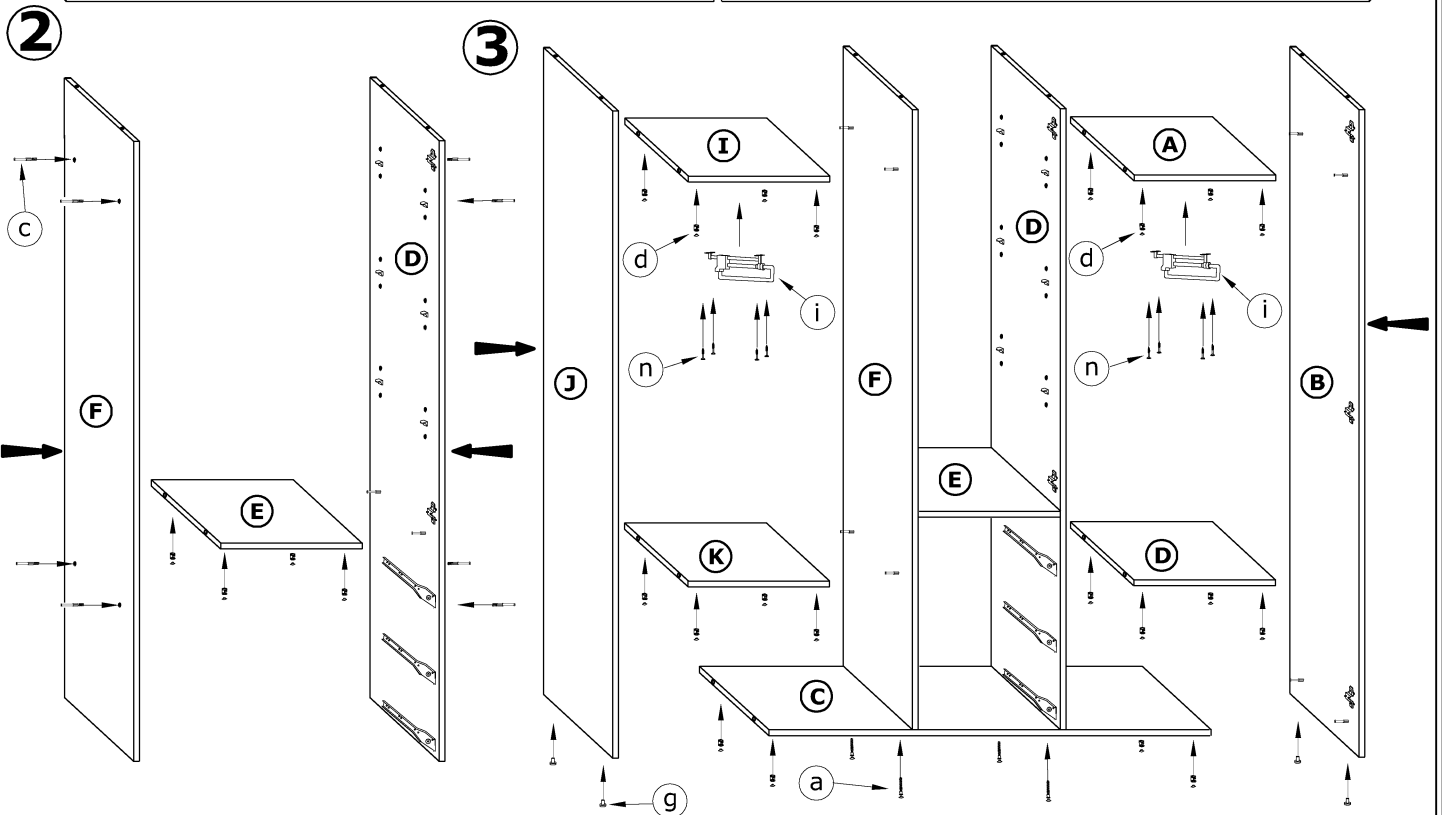
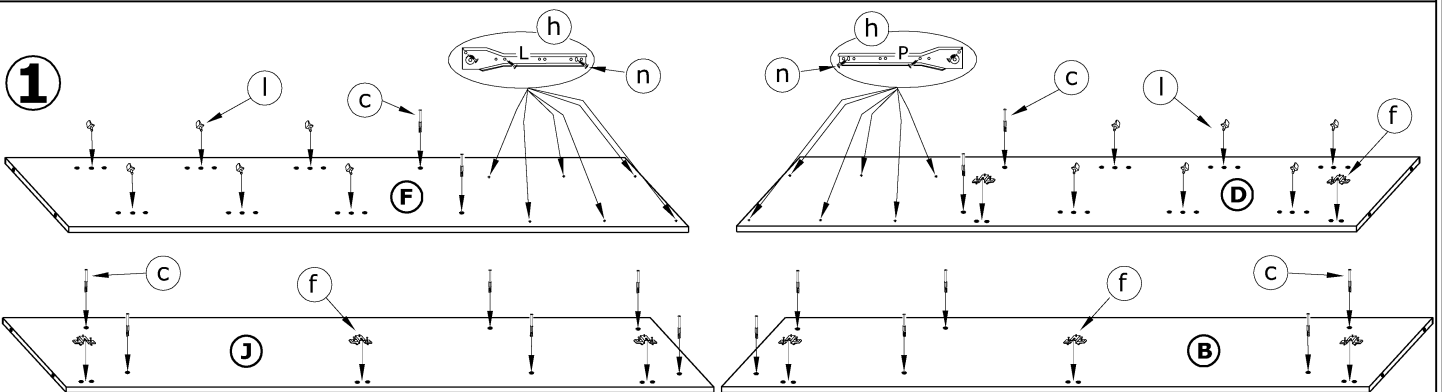

4

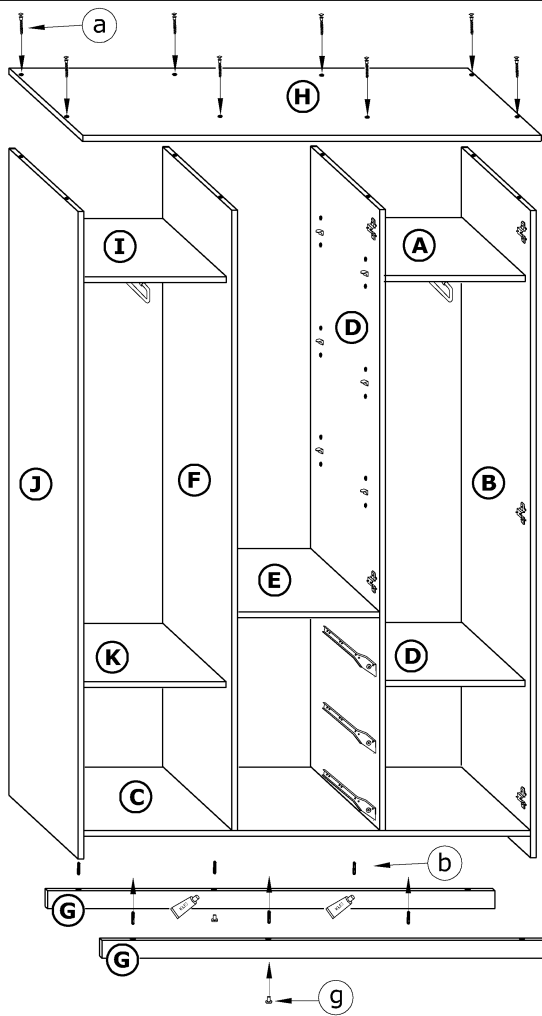

6

x 3

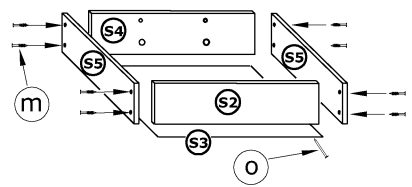

7

x 3

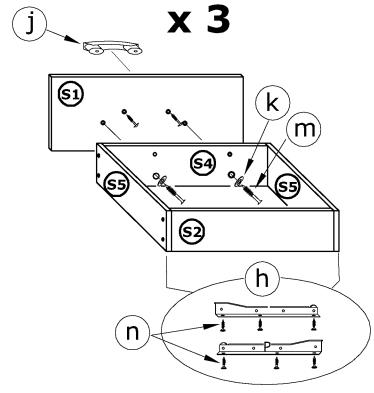

5

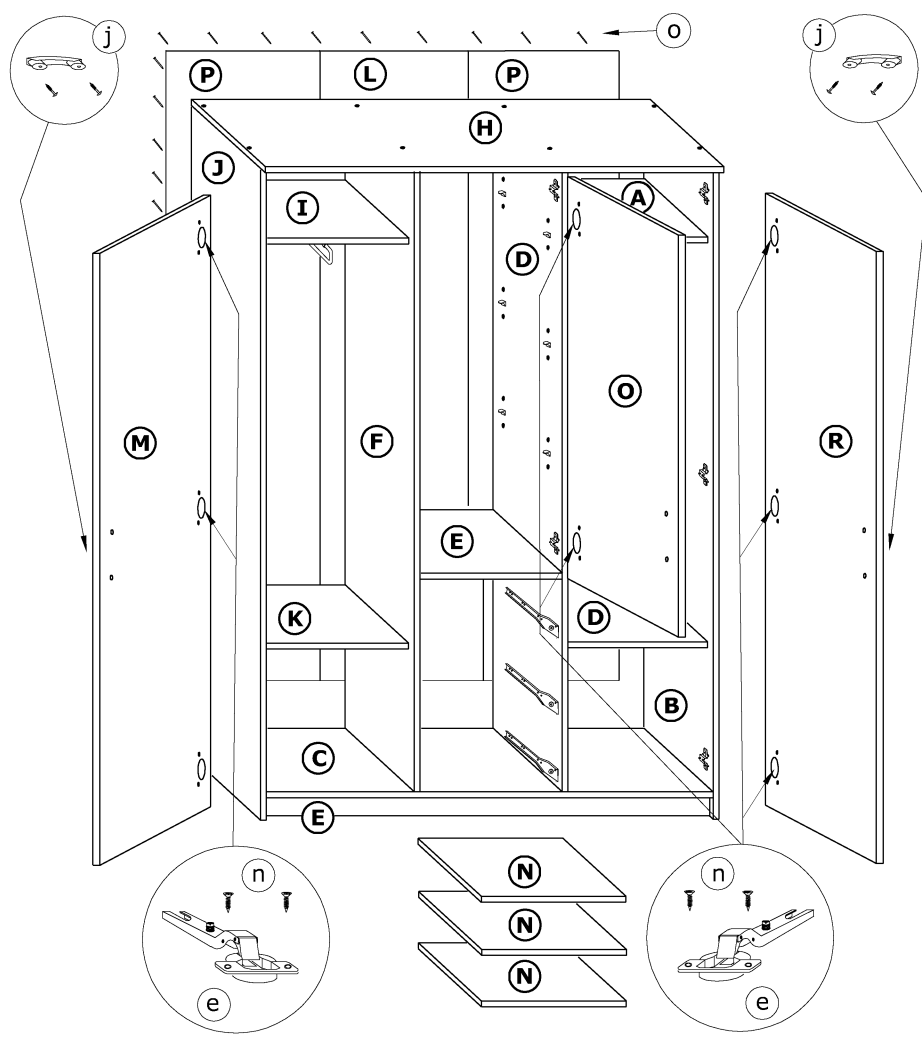

8

